

# User's Manual

## LT-800 Stationary Transmitter

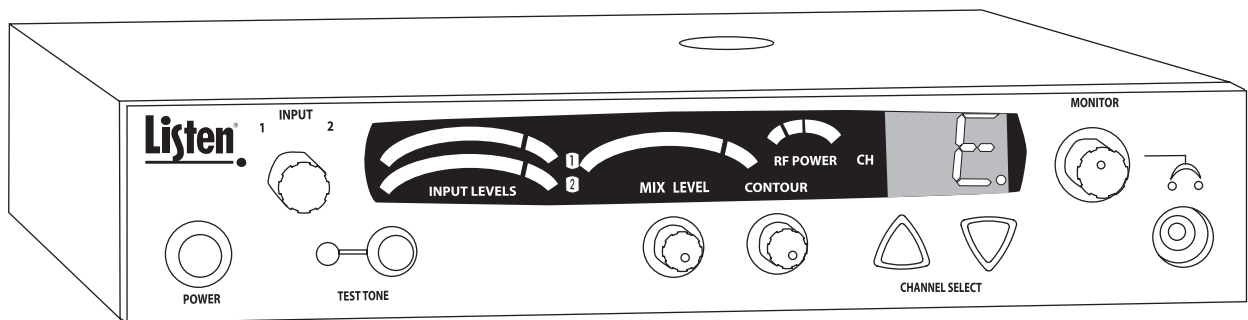

Don't miss a single sound. Listen.

# Listen<sup>®</sup>

[www.ListenTech.com](http://www.ListenTech.com)

Listen Technologies Corporation  
8535 South 700 West, Suite A  
Sandy, Utah 84070-2515 USA  
Telephone: +1.801.233.8992  
Toll Free (North America): 1.800.330.0891  
Fax: +1.801.233.8995  
E-mail: [info@ListenTech.com](mailto:info@ListenTech.com)

Listen<sup>®</sup> and the Listen logo are registered trademarks of Listen Technologies Corporation

Dear Valued Customer,

Thank you for choosing Listen! All of us at Listen are dedicated to providing you the highest quality products and prompt, efficient customer care. Our products are manufactured in an ISO-9000 factory that has been independently certified to the highest quality standards. We stand ready to answer any questions you might have during installation or in the operation of our products. Should there be any problems with your Listen products, we are ready to help you in any way we can. Should you have any comments on how we might improve our products or our service, we're here to listen. Here's how to reach us:

Telephone: +1.801.233.8992  
Fax: 1.801.233.8995  
Toll Free (North America): 1.800.330.0891  
E-Mail: support@ListenTech.com  
Web: www.ListenTech.com

Thank you... and enjoy your listening experience!

Best regards,

The Listen Team



## LT-800 Package Contents

- LT-800 Stationary Transmitter (72MHz or 216MHz)
- LA-201 120 VAC Power Supply
- LA-121 BNC Adapter (72MHz model only)
- Warranty Card
- User Manual



## Listen Part Number

72 MHz: LT-800-072  
216 MHz: LT-800-216

## Optional Accessories

See page 18

## Table of Contents

Architectural Specifications .....	2
Specifications .....	2
Block Diagram .....	3
Quick Reference .....	4
Setup Instructions .....	5
Audio Control .....	6
Operating Instructions .....	7
Transmission .....	7
Listen SQ™ .....	8
Channel Selection .....	9
RF Reception Maximization Strategies .....	10
Coaxial Cable .....	11
72 MHz Frequency Compatibility Table .....	12
216 MHz Frequency Compatibility Table .....	13
Troubleshooting .....	14
Compliance Notice .....	16
FCC Statement .....	16
Warranty .....	17
Optional Accessories .....	18

## Specifications

### Architectural Specifications

The stationary FM transmitter shall be capable of broadcasting on 57 channels. The transmitter shall have a SNR of 80dB or greater. The output power shall be adjustable to quarter, half or full. Channel tuning shall be capable of being locked. The device shall broadcast on both wide and narrow band channels. The device shall have an audio frequency response of 63Hz to 15KHz,  $\pm 3\text{dB}$  at 72MHz, or of 63Hz to 10kHz,  $\pm 3\text{dB}$  at 216MHz. It shall have two mixing audio inputs. The device shall have the following audio controls: input level, mix level and an adjustable low pass shelving filter. The Listen LT-800 is specified.

### Specifications

Specification		LT-800-072	LT-800-216
RF	RF Frequency Range	72.025 - 75.975 MHz	216.025 - 216.987 MHz
	Number of Channels	57 (17 wide, 40 narrow)	57 (19 wide, 38 narrow)
	Frequency Accuracy	$\pm .005\%$ stability 0° to 50°C (32° to 122° F)	
	Transmitter Stability	50 PPM	
	Transmitter Range	1,500 ft (457.2m)	3,000 ft (914.4m)
	Output Power	8,000uV at 3m	100mW (Max allowed by FCC)
	Antenna	Several available. See <a href="http://www.ListenTech.com">www.ListenTech.com</a> for details	
	Antenna Connector	Reverse BNC	BNC
Compliance	FCC Part 15, Industry Canada		
Audio	** All system specifications are wireless end-to-end		
	System Frequency Response	63Hz - 15kHz ( $\pm 3\text{dB}$ )	63Hz - 10kHz ( $\pm 3\text{dB}$ )
	System Signal to Noise Ratio (A-weighted)	SQ enabled: 80dB; SQ disabled 60dB	SQ enabled: 80dB; SQ disabled 50dB
	System Distortion	<2% total harmonic distortion (THD) at 80% deviation	
	Audio Input 1	Rear panel. Female-XLR and 1/4 in combo connector, balanced, -55/0dBu (mic/line) nominal input level adjustable, -30/+21 dBu (mic/line) maximum, impedance 1k/20k Ohms (line/mic)	
	Audio Input 2	Rear panel. One Phono connector, unbalanced, -10/+10dBu (line/speaker) nominal input level adjustable, +30dBu maximum, impedance 100k Ohms	
	Combined Audio Output (Mix)	Rear panel. One Phono connector, unbalanced, 0dBu nominal output level, +19dBu maximum, impedance 10 Ohms.	
	Headphone Output	Front panel. One 3.5mm connector, unbalanced, adjustable output level, +14dBu 250mW, maximum, impedance 32 Ohms.	
Controls	RF Power Selection	Rear panel. Full, 1/2, 1/4 (see "Output Power" above).	
	Set-up Controls	Front Panel. Input level, mix level (modulation), contour equalization	
	User Controls	RF power, test tone, channel UP and DOWN, Input 1: line or mic level, Input 2: speaker or line level.	
	Programming	Channel selection can be locked by holding the UP and DOWN button 5 seconds.	
Indicators	Input VU Meter	Dual Ten step LED (eight green, two red)	
	Mix VU Meter	Ten step LED (eight green, two red)	
	RF Power	Four step green LED	
	Power	Green LED illuminates when the unit is powered up	
	LCD Display	Channel and lock status	
	Test Tone	Red LED illuminates when test tone enabled	
Power	Power Supply Type	In-line power supply, Listen part number LA-201	
	Power Supply Input	120VAC, 60 Hz, 19 watts (maximum continuous)	
	Power Supply Output	15VAC, 1A	
	Power Supply Connector	.02 in OD x .01 in ID (5.0mm x 2.5mm), barrel type	
	Compliance	UL Listed	
Physical	Dimensions	8.0 in x 8.0 in x 1.75 in WxDxH (20.3cm x 20.3cm x 4.45cm)	
	Unit Weight	3.0 lbs (1.4kg)	
	Unit Weight with LA-201 Power Supply	4.4 lbs (2.0kg)	
	Shipping Weight	5.0 lbs (2.3 kg)	
	Rack Mounting	1/2 rack unit (RU)	
Environmental	Temperature - Operation	-10° to +40°C (14° to 104°F)	
	Temperature - Storage	-20° to +50°C (-4° to 122° F)	
	Humidity	0 to 95% relative humidity, non-condensing	

# LT-800 Block Diagram

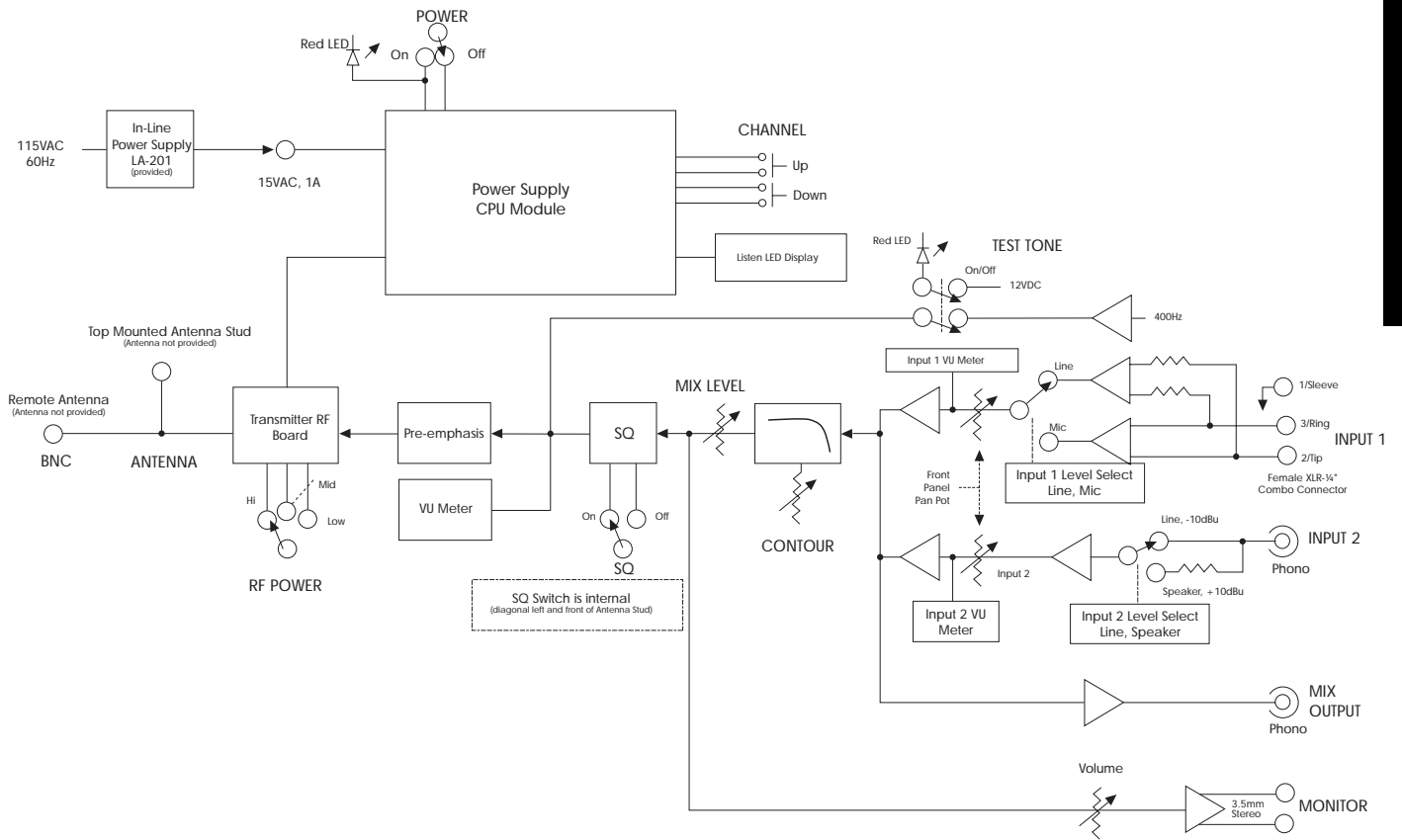

## Quick Reference

### LT-800 Front Panel: Controls & Displays

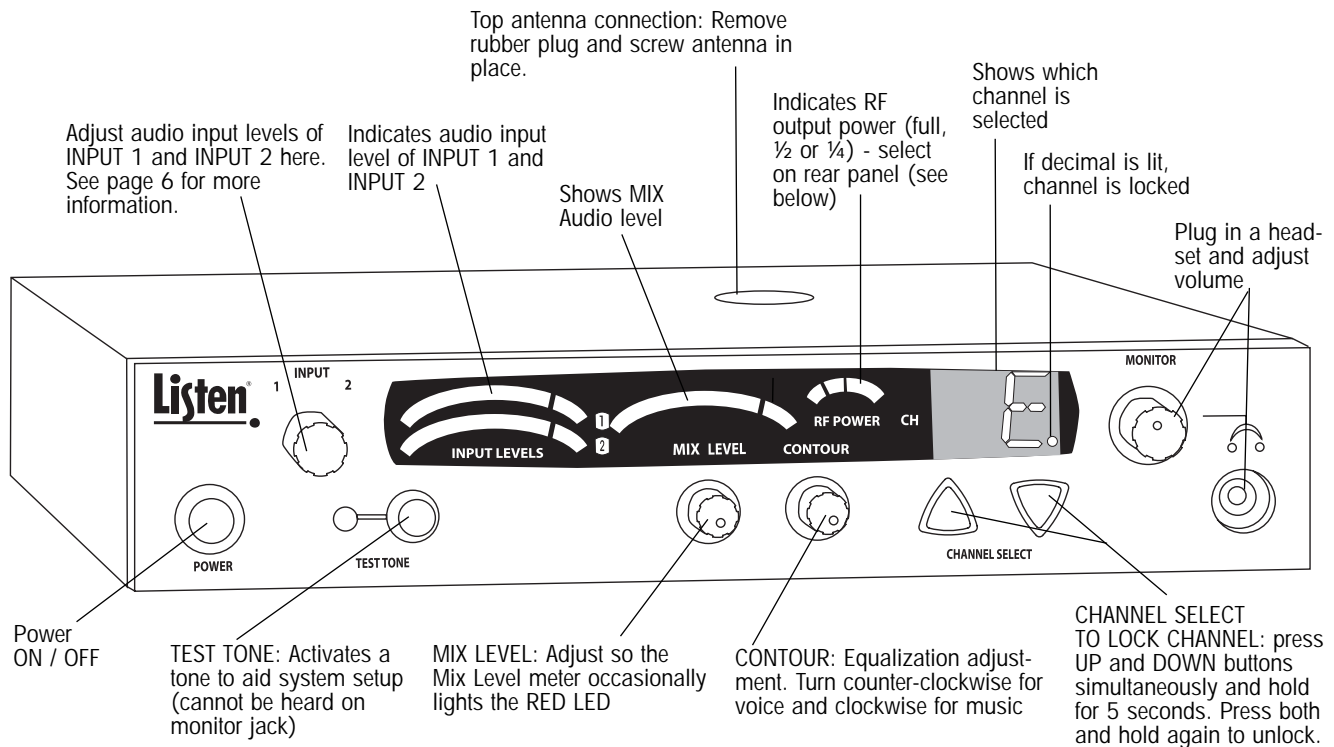

### LT-800 Back Panel: Connections and Settings

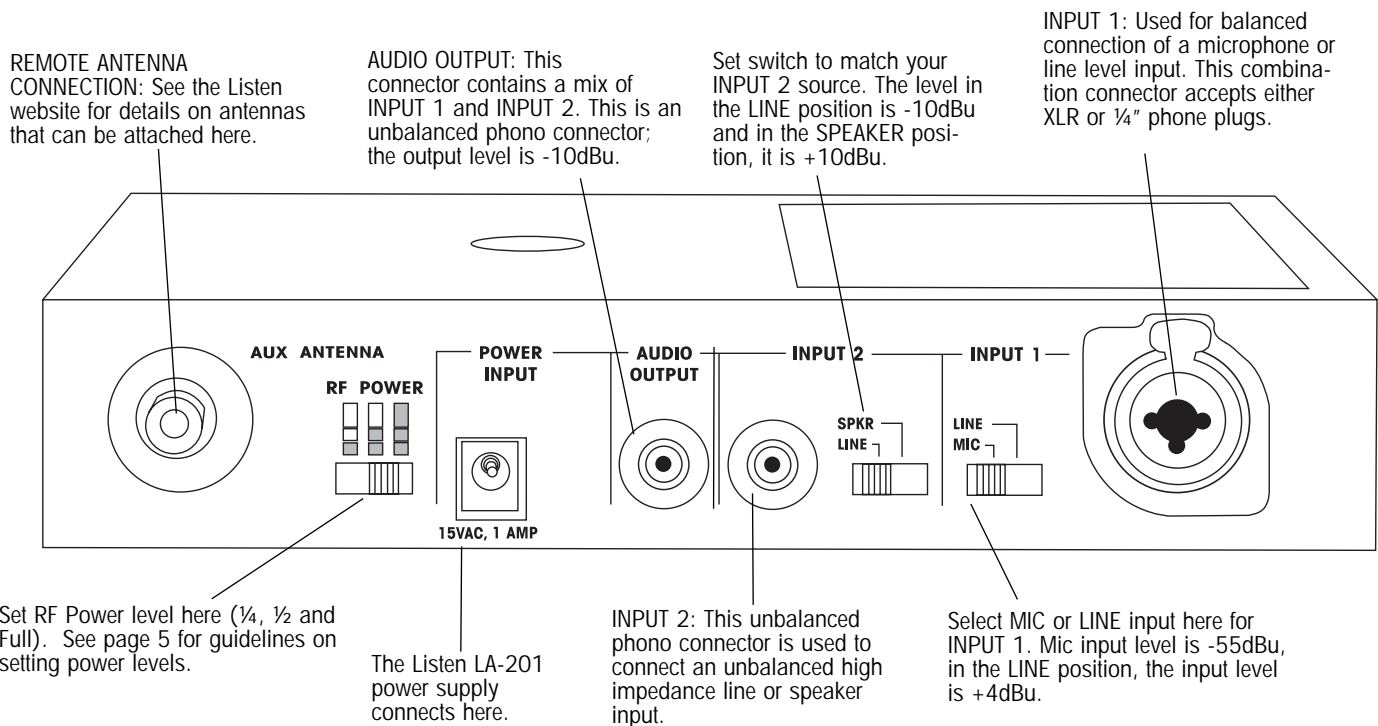

# LT-800 Setup Instructions

## 1 Remove the product

Remove outer packaging and plastic cover. Inspect for physical damage.

## 2 Set SQ Switch

The SQ switch comes in the ON position. This is the recommended position. Make sure receivers you are using have SQ on as well (factory default). See page 8 for an explanation of SQ. Remove the rubber plug from the top of the unit. In a good light, locate the SQ switch through the antenna opening in the top of the unit. The switch is located next to the antenna connector inside the unit. Move the switch toward the front of the unit to enable SQ; move the switch toward the back of unit to disable SQ.

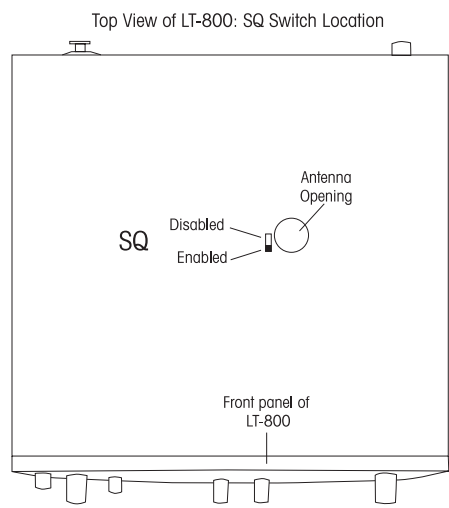

Note: If you will be using your LT-800 with receivers that do not have SQ capability, disable the SQ feature.

## 3 For rack mounting

If rack mounting the unit, install the optional rack mount kit (part# LA-326) according to the instructions included with the kit, then install the LT-800 in the rack.

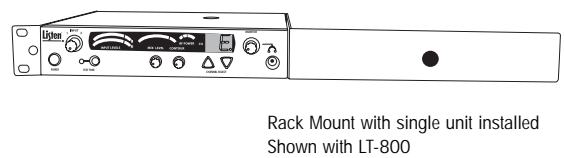
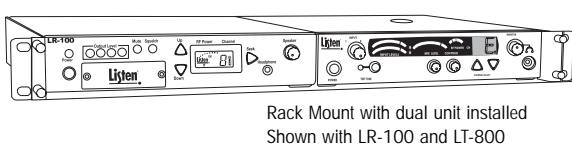

## 4 Connect power supply to unit

Plug the power supply into the power connector on the back panel. Do not connect to AC power yet. (Only use a Listen approved power supply. The LA-201, an in-line transformer, is the approved power supply for this unit.)

## 5 Connect antenna

Connect the antenna (not included) according to the installation instructions. Only use an antenna supplied by Listen. If you are connecting the antenna directly to the top of the LT-800, you will need to remove the rubber plug on top of the unit. If you are using a remote antenna connected to the rear of the unit, do not connect an antenna to the top connector. See page 18 for antenna options, or refer to the Listen website for remote antenna options.

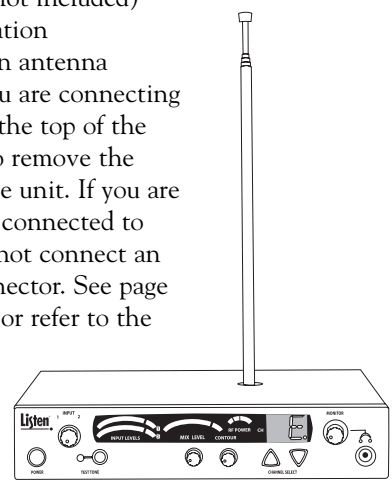

LT-800 with top mount LA-102-072MHz, LA-106-216MHz Telescoping Antenna connected through top of unit.

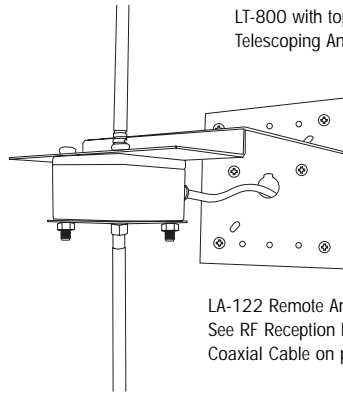

LA-122 Remote Antenna  
See RF Reception Maximization Strategies and Coaxial Cable on pages 10 and 11.

## 6 Set the RF power

Set the RF POWER switch for FULL, 1/2 or 1/4. (Level is indicated on the front panel.) The amount of transmitted RF power that you will need depends on your application. If you are operating other transmitters in the same environment and receivers may be used close to the antenna, it is best to have the transmitter's output power at its lowest level to reduce the possibility of interference.

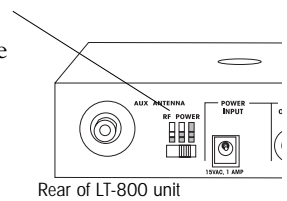

## LT-800 Setup Instructions

### 7 Power up

- Connect the LA-201 power supply to AC power.
- Press the POWER button on the front panel.
- Select the desired channel using the UP and DOWN buttons.
- If desired, lock in the selected channel by pressing the UP and DOWN buttons simultaneously and holding for 5 seconds.

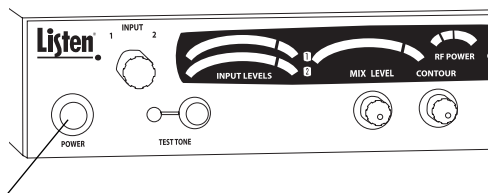

Press POWER button and verify power connections. When "ON", channel display LED will be lit.

### 8 Connect Audio Inputs

Connect audio source(s) to one or both audio input connections. Input 1 offers a choice of balanced XLR or 1/4" phono connection. Input 2 is an unbalanced phono connector.

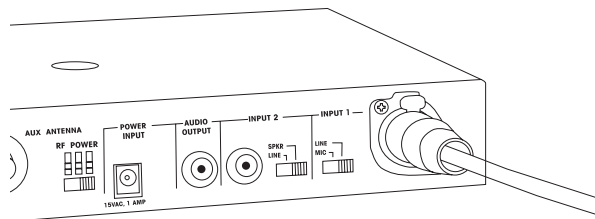

Rear of LT-800 with XLR connected to Input 1

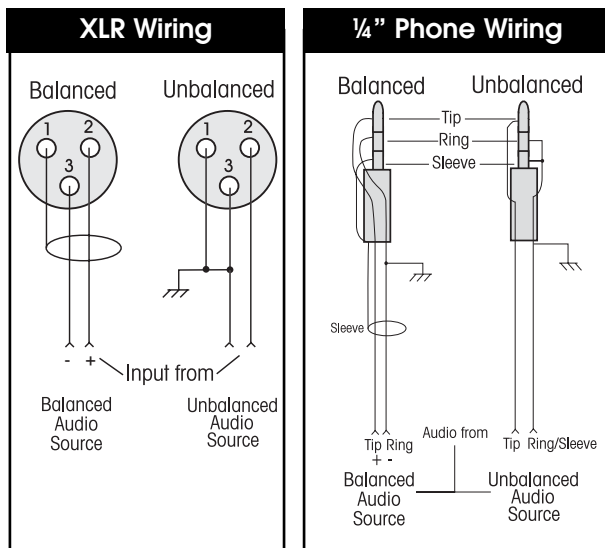

### 9 Connect balanced and unbalanced audio sources

Make sure that if you are connecting an unbalanced audio source to input 1 that pin 3 of the XLR or the ring of the 1/4" phone plug are connected to ground as shown.

### 10 Adjust audio input switches

With Input 1 Switch, select MIC or LINE input level; for Input 2 Switch, select LINE (-10dBu) or speaker (+10dBu) level. (See illustration on page 4.)

Use the headset jack to listen to audio source: With the audio source or sources active and the unit powered ON, plug a headset into the 3.5mm jack located on the LT-800's front panel to listen to the audio source. Adjust headset volume to a comfortable level.

Input levels can be viewed on the two VU meters on the front panel.

## LT-800 Audio Control

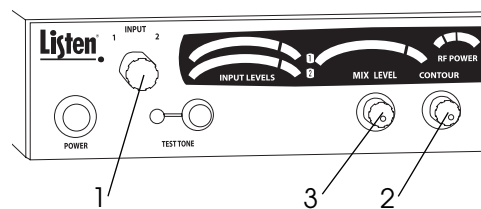

### 1 Adjust input

Adjust the INPUT knob counterclockwise to add gain to INPUT 1. This will decrease gain to input 2. Adjust INPUT knob clockwise to add gain to INPUT 2. This will decrease gain to input 1. If you have two audio sources connected to both INPUT 1 and 2, adjust the level of one input using the VU meter, then adjust the output level of the other audio source. Adjust the audio level so that the first VU meter does NOT peak in the red.

### 2 Adjust Contour

Adjust the CONTOUR knob counterclockwise if your audio source is mostly voice. Adjust the knob clockwise if your audio source is mostly music. The CONTOUR knob adjusts the relative equalization of the unit. This equalization boosts or cuts frequencies above 5kHz.

### 3 Adjust Mix Level

Adjust the mix level knob so that the audio level on the right VU meter occasionally peaks red. (This is the level adjustment for the combined output from Input 1 and Input 2.)



## Operating the LT-800

## LT-800 Transmission

### 1 Power unit on

### 2 Select a channel

Select the transmit channel by pressing the channel UP and DOWN buttons. See Channel Selection on page 9 for more information.

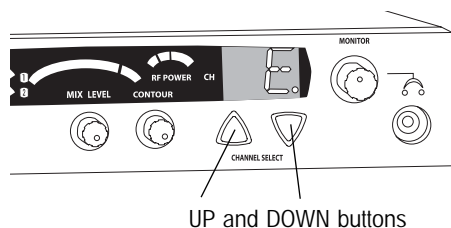

Can't change the channel? It may be locked. Press and hold both the UP and DOWN buttons simultaneously for 5 seconds until the decimal dot next to the channel turns off. Press again to lock in a new channel, if desired.

### 3 Test Tone, if necessary

To broadcast a test tone, press the test tone button. This helps to test receivers when no audio source is available. This tone is not heard from the monitor jack.

### Compatibility with other manufacturers

If you are using another manufacturer's receivers with the LT-800, determine their frequency then refer to Listen's Frequency Compatibility Tables (pages 12-13) to find the LT-800 channel that corresponds with the receiver's frequency. As much as possible, Listen has duplicated the wide band channel letters to cover frequencies of other major brands. However, we recommend verifying corresponding channel numbers and letters on the tables on pages 12-13.

## Listen SQ™ - Improving Your Listening Experience

We are accustomed to listening to low noise, high fidelity audio (delivered via CD, DVD, etc.). FM radio systems, such as those made by Listen, have more inherent noise compared to most sound systems. To reduce noise of our systems, Listen uses a noise reduction technology called ListenSQ™. Both the transmitter and receiver must have the SQ feature enabled to achieve the desired results. SQ is available on new Listen systems, including the system you received in this shipment. If you are planning to use this product with older Listen systems that do not have Listen SQ or equipment not manufactured by Listen, you should disable Listen SQ.

Your Listen equipment has been shipped to you with the SQ feature enabled. You may need to disable the SQ function for one or more of the following reasons:

1. You are using your new Listen system with older version Listen equipment that does not have the SQ function.
2. You are using your new Listen system with equipment supplied by other manufacturers.
3. You expect that end users may bring and use their own receivers that don't have the SQ function.

### **SQ Summary**

- Improves noise performance by at least 20dB
- SQ is NOT compatible with older version Listen products
- SQ is NOT compatible with other manufacturers' products
- SQ is NOT squelch
- To work properly, SQ must be enabled for both the transmitter and receivers
- SQ can be disabled to permit operation with older Listen products or other manufacturers' products

## Channel Selection

It is important to choose channels that are free from interference to achieve proper operation of your Listen equipment. This process is trial and error. Before turning on the transmitter, listen to the wide band channels (lettered channels at 72MHz and channels that start with a "2" for 216MHz when using a Listen receiver).

Listen to the audio through the headphone or via the speaker. Choose a channel with the least amount of interference. Unless you are interfacing with an existing narrowband transmission system, always use a wide band channel. If you are using multiple channels follow this process:

- a. **Same Space** If you are using multiple transmitters in the same space, the most number of channels that will work simultaneously is six at 72MHz and three at 216MHz. With all of the transmitters off, listen for interference on all the wide band channels via the headphone jack on a Listen receiver. Using the frequency compatibility tables on pages 12-13, eliminate any channels that have noticeable interference. Now choose the channels with the widest channel spacing. It is recommended that adjacent channels be spaced at least 300KHz. If there is no interference the following channels are recommended: A, C, E, I, J, and H for 72MHz and channels 2A, 2K and 2V at 216MHz.
- b. **Distributed Spacing** If you are using transmitters that are spread out over space, you can achieve more simultaneous broadcast channels. However, it is critical that your receiver(s) be located as close to its transmitter as possible. You can use adjacent channels (see frequency compatibility tables on pages 12-13) in this case as long as the adjacent channel transmitter is at least 50% further away from the receiver as its transmitter. Example: The transmitter for the receiver on channel E is 100 feet from the receiver. The adjacent channel transmitter on channel D should be at least 150 feet away.

It is highly recommended that after channel selection has been achieved, you lock the channel so that it cannot be changed by the user. To accomplish LOCK on the LT-800, press both the UP and DOWN buttons simultaneously for 5 seconds. Repeat the process to unlock.

### Notes in regard to using 72MHz and 216MHz systems:

- i. 72MHz is in a secondary frequency band. This means that other transmitters are licensed to use these frequencies. Thus, you may experience interference from paging transmitters and other types of transmissions. You will need to find a clear channel by listening to all the wide band channels.
- ii. 216MHz is a primary frequency band and no other types of transmissions are authorized to use it. Thus, you will find the highest probability of clear channels in this band. However, you may experience intermodulation of the TV Channel 13 aural carrier if there is a channel 13 transmitter in your area and you are close to the transmitter. If you cannot find a clear channel in 216MHz band due to channel 13, it is recommended that you switch to a 72MHz system.

### Wide Band Recommendation

Listen recommends that you always use a wide band channel unless you need to be compatible with existing narrow band receivers from other manufacturers. Wide band channels have lower noise than their narrow band counterparts.

#### At 72MHz

The LT-800 at 72MHz operates on 17 wide band channels and 40 narrow band channels.

- Letters= Wide Band Channels (Example: E)
- Numbers= Narrow Band Channels (Example: 32)

#### At 216MHz

The LT-800 at 216MHz operates on 19 wide band channels and 38 narrow band channels.

- "2" as left digit= Wide Band Channel (Example: 2C)
- "1" and "3" as left digits= Narrow Band Channels (Examples: 1A; 3R)

## RF Reception Maximization Strategies

For proper and dependable operation, Listen receivers should receive a strong and consistent signal from the originating transmitter. The following strategies should be used maximize this signal:

- a. When designing and installing your system, keep in mind that the location of both the transmitting and receiving antennas is critical to maximizing signal strength.
- b. Eliminate or minimize obstructions between the transmitting antenna and the receiving antenna.
- c. Minimize the distance between the transmitting and receiving antennas.
- d. Move transmitting and receiving antennas away from metal objects.
- e. Place the transmitting antenna as high as possible.
- f. Orient both transmitting and receiving antennas vertically.

**CAUTION:** When installing antennas, ensure the antenna is clear of power lines.

**NOTE:** If the RF signal to the 216MHz model receivers is too high, the audio will be distorted. This may happen if you are within 40 feet of the 216MHz transmitter.

Coaxial cable, connectors, and optional antenna mounting kits are available from Listen. Visit [www.ListenTech.com](http://www.ListenTech.com) or ask your dealer for details.

## Coaxial Cable

The antenna for the LT-800 can be mounted directly on the unit if desired. However, you may find that the unit will provide better performance when the antenna is located elsewhere. If you plan to mount the antenna in a different location than on the top of the unit, you must use cable and connectors rated at 50 Ohms. Although cable used for cable TV installations looks similar to this cable, it won't work with your Listen system.

If you need to run cable over a greater length than 50 feet for 216MHz applications or greater than 100 feet for 72MHz applications, we recommend that you use RG-8 cable rather than RG-58. It is a lower loss cable, meaning that more of your signal will reach the antenna.

Long cable runs can result in signal degradation due to "loss" characteristics of the cable. At 72MHz, there is an average loss of 2dB per 100 feet of cable and at 216MHz an average\* loss of 5 dB per 100 feet of cable. (A 3dB loss means half of your power has been lost.) However, it is better to suffer coaxial power loss than to try to shoot your signal through obstacles! Obstacles, especially metal, can create drop-outs or reflections of your signal that will result in poor listening conditions.

\*NOTE: There are many varieties of 50 Ohm, RG58 and RG8 cables. You may purchase a cable that is better or worse than this value. Please check with the cable vendor or manufacturer for exact specifications.

## 72MHz Compatibility Chart

Frequency MHz	Phonic Listen	Phonic Ear	Comtek	Phonak	Williams*	Gentner	Telex	Drake
72.0250	1	1	1	A1	(11, 1)			
72.0500					(2)	1		
72.0750	2	2	2	A2	(12, 3)			
72.1000	A	A	A	A	A, (13, 4)	2	A	72.1
72.1250	3	3	3	A3	(14, 5)			
72.1500					(6)	3		
72.1750	4	4	4	A4	(15, 7)			
72.2000	K	K	K	K	K, (8)	4	B	72.2
72.2250	5	5	5	K5	(16, 9)			
72.2500					(10)	5		
72.2750	6	6	6	K6	(17, 11)			
72.3000	B	B	B	B	B, (18, 12)	6	C	72.3
72.3250	7	7	7	B7	(19, 13)			
72.3500					(14)	7		
72.3750	8	8	8	B8	(20, 15)			
72.4000	N	N	N	N	N, (16)	8	D	72.4
72.4250	9	9	9	N9	(21, 17)			
72.4500					(18)	9		
72.4750	10	10	10	N0	(22, 19)			
72.5000	C	C	C	C	C, (23, 20)	10	E	72.5
72.5250	11	11	11	C1	(24, 21)			
72.5500					(22)	11		
72.5750	12	12	12	C2	(25, 33)			
72.6000	O	O	O	O	O, (24)	12	F	72.6
72.6250	13	13	13	O2	(26, 25)			
72.6500					(26)	13		
72.6750	14	14	14	4	(27)			
72.7000	D	D	D	D	D, (28)	14	G	72.7
72.7250	15	15	15	D5	(29)			
72.7500					(30)	15		
72.7750	16	16	16	D6	(30, 31)			
72.8000	P	P	P	P	P, (32)	16	H	72.8
72.8250	17	17	17	P7	(31, 33)			
72.8500					(34)	17		
72.8750	18	18	18	P8	(32, 35)			
72.9000	E	E	E	E	E, (33, 36)	18	I	72.9
72.9250	19	19	19	E9	(34, 37)			
72.9500					(38)	19		
72.9750	20	20	20	E0	(35, 39)			
74.6250	33	33	33	E3	(36, 40)			
74.6500					(41)	20		
74.6750	34	34	34	E4	(37, 42)			
74.7000	I	I	I	I	I, (38, 43)	21	O	
74.7250	35	35	35	I5	(39, 44)			
74.7500					(45)	22		
74.7750	36	36	36	I6	(40, 46)			
75.2250	37	37	37	I7	(41, 47)			
75.2500					(48)	23		
75.2750	38	38	38	I8	(42, 49)			
75.3000	J	J	J	J	J, (43, 50)	24	P	
75.3250	39	39	39	J9	(55, 51)			
75.3500					(52)	25		
75.3750	40	40	40	J0	(45, 53)			
75.4000	R	R	R	R	R, (54)	26	Q	
75.4250	21	21	21	R1	(46, 55)			
75.4500					(56)	27		
75.4750	22	22	22	R2	(47, 57)			
75.5000	F	F	F	F	F, (48, 58)	28	J	75.5
75.5250	23	23	23	F3	(49, 59)			
75.5500					(60)	29		
75.5750	24	24	24	F4	(50, 61)			
75.6000	S	S	S	S	S, (62)	30	K	75.6
75.6250	25	25	25	S5	(51, 63)			
75.6500					(64)	31		
75.6750	26	26	26	S6	(52, 65)			
75.7000	G	G	G	G	G, (53, 66)	32	L	75.7
75.7250	27	27	27	G7	(54, 67)			
75.7500					(68)	33		
75.7750	28	28	28	G8	(55, 69)			
75.8000	T	T	T	T	T, (70)	34	M	75.8
75.8250	29	29	29	T9	(56, 71)			
75.8500					(72)	35		
75.8750	30	30	30	T0	(57, 73)			
75.9000	H	H	H	H	H, (58, 74)	36	N	75.9
75.9250	31	31	31	H1	(59, 75)			
75.9500					(76)	37		
75.9750	32	32	32	H2	(60, 77)			

\*Parenthesis indicate T35 and T20 narrowband.  
NOTE: Wideband frequencies in highlighted rows.

## 216MHz Compatibility Chart

Frequency MHz	Listen	Phonic Ear	Comtek	Phonak	Williams	Gentner	CSI	AVR	Light Speed
216.0125	1A		1	1				C01	N01
216.0250	2A	41	41	41		1	1		
216.0375	3A		2	2					
216.0625	1B		3	21					
216.0750	2B	42	42	42		2	10		
216.0875	3B		4	4					
216.1125	1C		5	5				C05	
216.1250	2C	43	43	43	A	3	6		
216.1375	3C		6	22					
216.1625	1D		7	23					
216.1750	2D	44	44	44	B	4	14		
216.1875	3D		8	8					
216.2125	1E		9	9				C09	N09
216.2250	2E	45	45	45	C	5	2		
216.2375	3E		10	24					
216.2625	1F		11	25					
216.2750	2F	46	46	46	D	6	11		
216.2875	3F		12	12				C12	N12
216.3125	1G		13	13					
216.3250	2G	47	47	47	E	7	7		
216.3375	3G		14	26					
216.3625	1H		15	27					
216.3750	2H	48	48	48	F	8	15		
216.3875	3H		16	16				C18	N18
216.4125	1J		17	17				C21	
216.4250	2J	49	49	49	G	9	18		
216.4375	3J		18	18					
216.5125	1K		21	61					
216.5250	2K	51	51	29	H	10	3		
216.5375	3K		22	62					
216.5625	1L		23	28					
216.5750	2L	52	52	52	I	11	12		
216.5875	3L		24	64				C24	N64
216.6125	1M		25	65				C25	
216.6250	2M	53	53	53	J	12	8		
216.6375	3M		26	81					
216.6625	1N		27	82					
216.6750	2N	54	54	54	K	13	16		
216.6875	3N		28	68					
216.7125	1P		29	69				C29	
216.7250	2P	55	55	55	L	14	19		
216.7375	3P		30	83					
216.7625	1R		31	84					
216.7750	2R	56	56	56		15	4		
216.7875	3R		32	72				C32	N72
216.8125	1S		33	73				C33	
216.8250	2S	57	57	57			13		
216.8375	3S		34	76					
216.8625	1T		35	85					
216.8750	2T	58	58	58			9		
216.8875	3T		36	86					
216.9125	1U		37	77				C37	N77
216.9250	2U	59	59	59			17		
216.9375	3U		38	88					
216.9625	1V		39	79				C39	
216.9750	2V	60	60	60			5		
216.9875	3V		40	80				C40	N80

NOTE: Wideband frequencies in highlighted rows.

## LT-800 Troubleshooting

### **The LT-800 has no power**

Make sure the LA-201 power transformer is connected to a power source and is connected to the jack marked "Power Input". Make sure the POWER button is pressed.

### **There is no audio or the audio level is too low**

Make sure that you have an audio source properly connected to Input 1 and/or Input 2. The Input 1 or Input 2 switches must be in the correct position for the appropriate input level. For example: if you are using the output of a mixer on Input 2, the switch should be in the Line position. If it were to be in the Speaker position, the level would be too low. Also, check the Input knob to ensure it is properly adjusted. You should be able to see the VU meter deflect on Input 1 or Input 2 corresponding with the input level of the audio source. Try connecting a headset to the front panel jack and adjusting the Monitor volume control so that you can listen to the audio source.

### **The audio is distorted**

Check to make sure you have the input level select switches in the proper position. You may be providing too much audio level for the input stage to handle. Make sure the SQ switch is in the correct position on both the LT-800 and the receivers you are using. If your receivers do not have SQ, make sure the SQ switch inside the top of the LT-800 is turned off (see page 5).

### **There is hum in the audio**

Make sure you have properly grounded the audio source to the LT-800. Check the connections from the audio source to the LT-800. If you can, try to use a balanced audio source - this will reduce the chance of creating hum. Try connecting a ground from the LT-800 to ground and/or to the ground of the source audio.

### **There is a tone**

The Test Tone button has been pressed (its LED light is on). Push the Test Tone button to turn off the tone.

### **I cannot change the broadcast channel**

When the unit is locked, the decimal by the channel indicator is illuminated. The unit is locked. To unlock, press the Up and Down buttons simultaneously for 5 seconds.

### **The Audio Input 1 sounds "finny"**

If you are using an unbalanced audio source, make sure Pin 3 on the XLR or the ring on the ¼" plug is grounded (see page 6).

### **I cannot pick up the signal on the receiver**

Check to make sure the receiver and the transmitter are using the same frequency band (i.e. 72MHz or 216MHz) and that they are on the same channel. Make sure the LT-800 has an antenna connected. Ensure that the receiver has an antenna (LR-500, 400 or 300 headset or LR-100 or 600 antenna).

### **I can pick up the signal on the receiver, but it sounds like it's not tuned in**

Check to make sure the transmitter and receiver are on exactly the same channel. It's a good idea to lock the channels once they have been set. To lock the LT-800, press the UP and DOWN buttons simultaneously for a 5 seconds (see page 6, Power Up instructions).



## LT-800 Troubleshooting

### **I'm using another brand of receiver - how do I tell which channel to use?**

Refer to Listen's Frequency Compatibility Tables (pages 12-13). Adjust Listen's transmitter to the same frequency as the other major brand. Since Listen products can access 57 channels, they will most likely receive on the same fixed channel or channels of other major brands. If you are using another brand of receiver, make sure you have turned off the SQ feature on the Listen product(s).

### **There is not sufficient range**

First make sure that the receivers you are using are operating properly, then make sure that you have an antenna connected either to the top of the LT-800 transmitter or connected to the back of the unit (but not both!). The antenna should be as high as possible and free of obstacles. In addition make sure you are using the correct antenna type for your unit. You might want to use a remote antenna (provided by Listen) that can be mounted on a mast or wall. Try using different frequencies to find one with less interference.

### **There is interference in my transmission**

Ensure that the transmitter and receivers are on the same channel. Verify that there are no other transmitters on the same channel or a close channel to the one exhibiting interference. Try different channels until you find a clear channel. If this does not work, try a different frequency band (i.e. if you are using 72MHz, try 216 MHz or vice versa). Please contact Listen support for assistance and a return authorization (RA) number to exchange product (no charge) for alternate frequency equipment.

### **End users are adjusting the unit.**

First, lock the channel by pressing the UP and DOWN buttons simultaneously for 5 seconds. Consider removing the INPUT, MIX LEVEL and CONTOUR knobs. You can order from Listen a rack mount kit and security cover that will limit access to the unit.

### **If you are using other manufacturers' receivers and the sound is distorted**

It is probably because the receiver is not designed to handle the +25kHz deviation of the Listen transmitter. This can be corrected by turning the Mix Level knob down. Another possibility is that you have enabled the SQ function of the LT-800, and this feature is not available in other companies' products. You will need to disable SQ in this event (see page 5).

### **Several transmitters operating in the same environment**

For this, you'll need to choose your transmitting frequencies carefully. See page 9 for more details.

### **Can I have two antenna's connected to my transmitter?**

The LT-800 transmitter can use only one antenna connection at a time. You may connect either a top mount antenna through the top antenna port, or a remote antenna connected to the BNC connection on the rear of the unit. If antenna's are simultaneously connected to both ports the transmitter will have extremely poor broadcast performance and range.

## Compliance Notice

This device complies with part 15 of the FCC Rules. Operation is subject to the following two conditions: (1) These devices may not cause harmful interference, and (2) these devices must accept any interference received, including interference that may cause undesirable operation.

### **Listen's LT-800 Transmitter (216MHz only)**

Listen's LT-800 transmitter is authorized by rule under the Low Power Radio Service (47 C.F.R. Part 95) and must not cause harmful interference to TV reception or United States Navy SPASUR installations. You do not need an FCC license to operate these transmitters. These transmitters may only be used to provide: auditory assistance to persons with disabilities, persons who require language translation, or persons in educational settings; health care services to the ill; law enforcement tracking services under agreement with a law enforcement agency; or automated maritime telecommunications system (AMTS) network control communications. Two-way voice communications and all other types of uses not mentioned above are expressly prohibited.

CAUTION: Changes or modifications not expressly approved by the party responsible for compliance could void the user's authority to operate Listen's equipment.

## FCC Statement

This equipment has been tested and found to comply with the limits for a class B digital device, pursuant to part 15 of the FCC Rules. These limits are designed to provide reasonable protection against harmful interference in a residential installation. This equipment generates, uses and can radiate radio frequency energy and if not installed and used in accordance with the instructions, may cause harmful interference to radio communications. However, there is no guarantee that interference will not occur in a particular installation. If this equipment does cause harmful interference to radio or television reception, which can be determined by turning the equipment off and on, the user is encouraged to try to correct the interference by one or more of the following measures:

- Reorient or relocate the receiving antenna.
- Increase the separation between the equipment and receiver.
- Connect the equipment into an outlet on a circuit different from that to which the receiver is connected.
- Consult the dealer or an experienced radio/TV technician for help.

This equipment has been certified to comply with the limits for a class B computing device, pursuant to FCC and IC Rules. In order to maintain compliance with FCC and IC regulations, shielded cables must be used with this equipment. Operation with non-approved equipment or unshielded cables is likely to result in interference to radio and TV reception. The user is cautioned that changes and modifications made to the equipment without the approval of manufacturer could void the user's authority to operate this equipment.

## Warranty

Listen Technologies Corporation (Listen®) warrants the LT-800 Stationary Transmitter to be free from defects in workmanship and material under normal use and conditions for the useful lifetime of the product from date of purchase. This warranty is only available to the original end purchaser of the product and cannot be transferred. Warranty is only valid if warranty card has been returned within 90 days of purchase. This warranty is void if damage occurred because of misuse or if the product has been repaired or modified by anyone other than a factory authorized service technician. Warranty does not cover normal wear and tear on the product or any other physical damage unless the damage was the result of a manufacturing defect. Listen is not liable for consequential damages due to any failure of equipment to perform as intended. Listen shall bear no responsibility or obligation with respect to the manner of use of any equipment sold by it. Listen specifically disclaims and negates any warranty of merchantability or fitness of use of such equipment including, without limitation, any warranty that the use of such equipment for any purpose will comply with applicable laws and regulations. The terms of the warranty are governed by the laws of the state of Utah, USA. Listen will only accept returned products with prepaid shipping and with a return authorization number. To receive a return authorization number call 1.800.330.0891 or +1.801.233.8992. Please see [www.ListenTech.com](http://www.ListenTech.com) or contact Listen for complete warranty details.

## Optional Accessories



**LA-122 Universal Antenna Kit**

The single solution for all of your indoor remote antenna needs. Includes: 72 and 216MHz components; flexible and rigid dipoles and monopole radials; hardware for multiple mounting configurations; and 25 feet (7.6 m) of RG58 coax cable.

## Other Stationary Unit Antennas



**Telescoping\***

(Top Mount)

LA-106 for 72MHz or  
LA-102 for 216MHz



**72MHz Helical\***

(Top Mount)

LA-101 for 72MHz



**90 Degree Helical**

(Rear Mount)

LA-123 for 72MHz or  
LA-124 for 216MHz



**216MHz Ground Plane**

(Remote Mount,  
outdoor)

LA-107 for 216MHz

## LT-800 Rack Mount Options



**LA-326 Rack Mounting Kit\***

Includes components for single and dual rack configuration and a security cover



**Antenna Kit for the LA-326 Rack Mount Kit**

LA-125 for 72MHz and  
LA-126 for 216MHz

\* Rack mounted units cannot use the LA-106, LA-102 or LA-101 top mounted antenna.

## Optional Accessories continued



**Replacement  
115vac/60hZ  
Power Supply**  
LA-201



**BNC Adapter**  
LA-121



**BNC Connector  
for RG58**  
LA-127



**BNC Connector  
for RG8**  
LA-128



**RG58 Coaxial  
Cable**  
LA-112



**RG8 Low  
Loss Coaxial  
Cable**  
LA-113



**Installation of  
BNC Connectors**  
LA-114





**Listen**<sup>®</sup>

*[www.ListenTech.com](http://www.ListenTech.com)*

Listen Technologies Corporation  
8535 South 700 West, Suite A  
Sandy, Utah 84070-2515 USA  
Telephone: +1.801.233.8992  
Toll Free (North America): 1.800.330.0891  
Fax: +1.801.233.8995  
E-mail: [info@ListenTech.com](mailto:info@ListenTech.com)